

0 601 638 303

Issue } 02-05-06
Stand }

Fig./Abb. 1

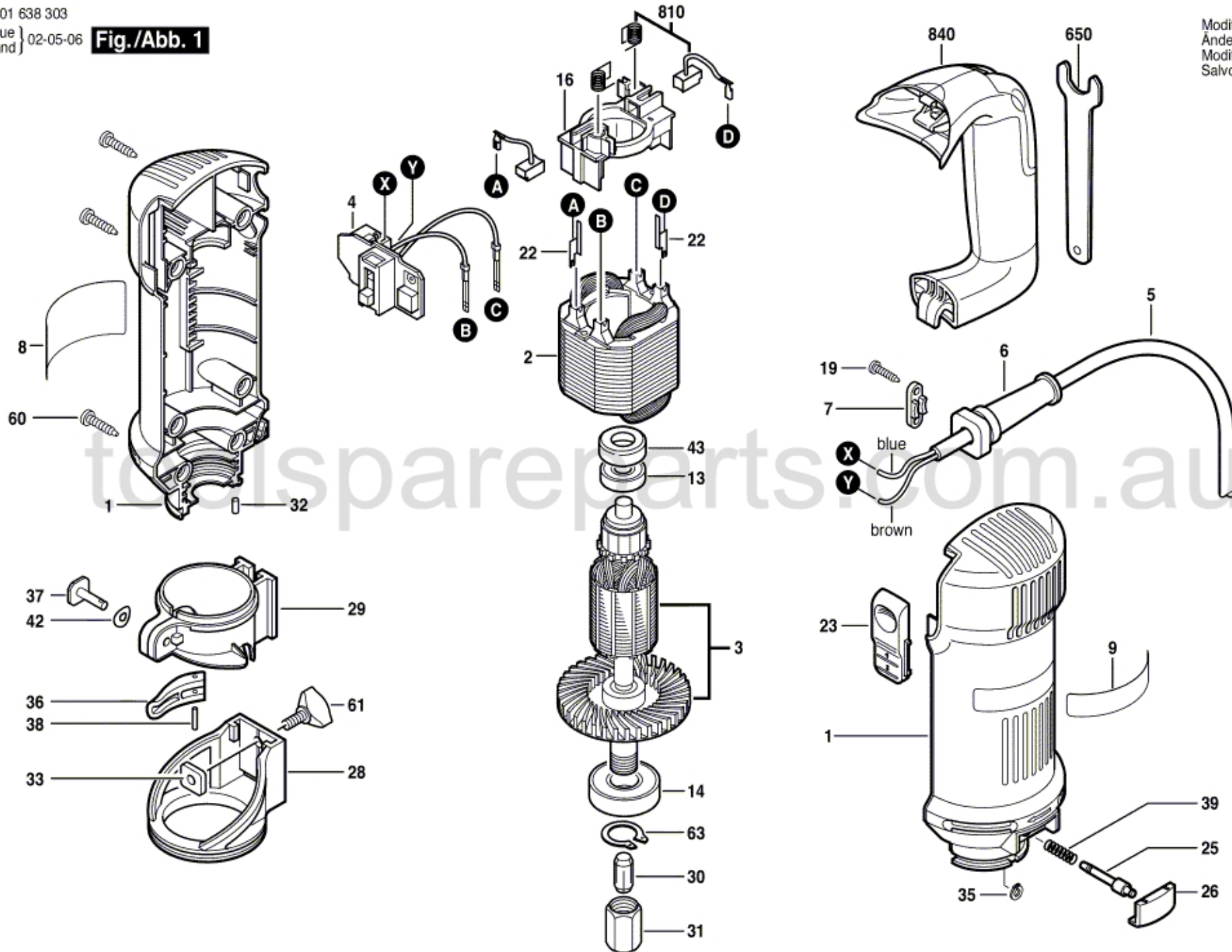

Modifications reserved
Änderungen vorbehalten
Modifications réservées
Salvo modificaciones